

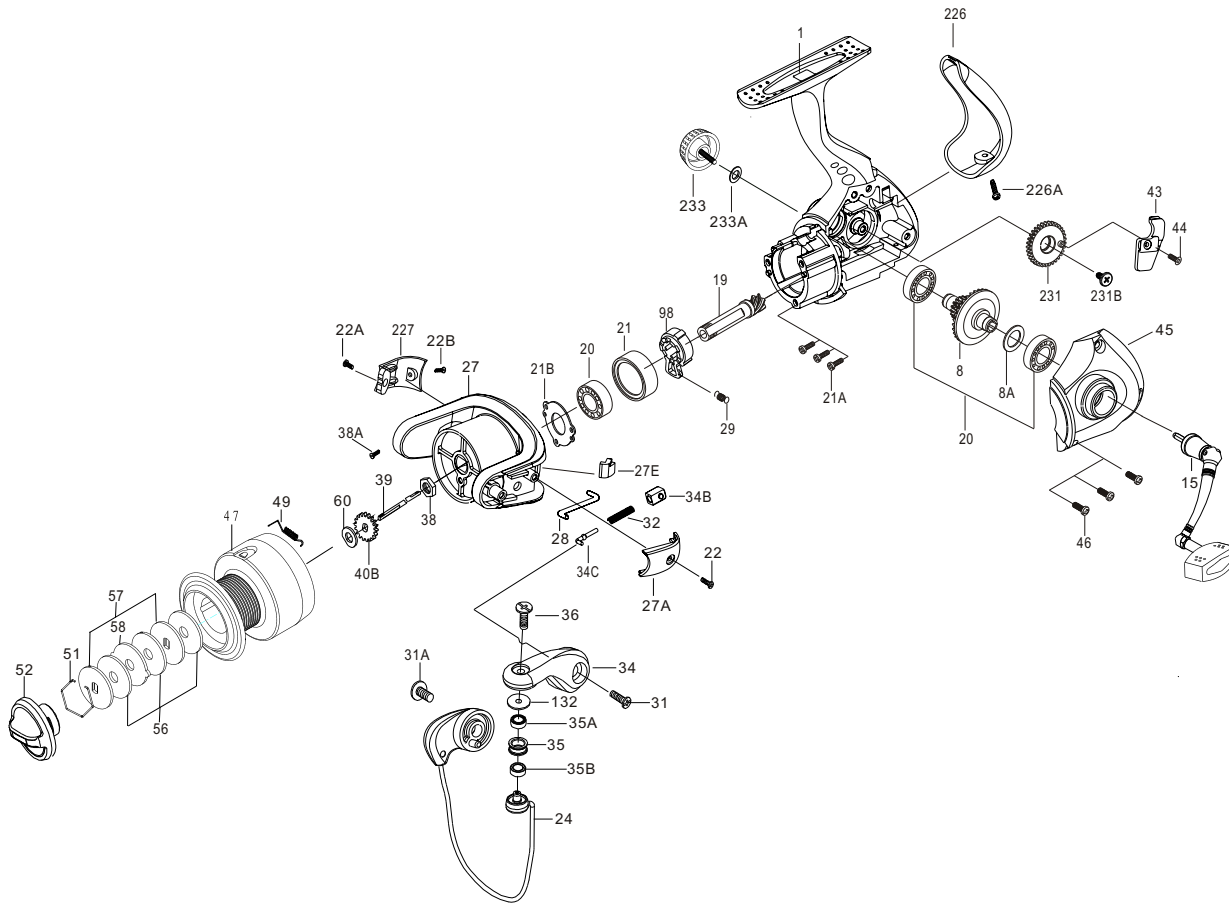

PARTS LIST FOR MODEL SV6000



KEY

NO. DESCRIPTION

1	HOUSING
8	Main Gear Assembly
8A	Main Gear Shim
15	Handle Assembly
19	Pinion Gear
20	Ball Bearing(3req.)
21	Collar
21A	Bearing Mounting Screw(3 req.)
21B	Ball Bearing Fixed Washer
22	Bail Arm Cover Screw
22A	Side Cover Screw
22B	Side Cover Screw
24	Bail Wire
27	Rotor Cup
27A	Bail Pivot Cover
27E	Balance Weight
28	Trip Lever
29	Spring
31	Bail Arm Screw
31A	Bail Wire Screw
32	Bail Spring
34	Bail Arm
34B	Pivot Guide
34C	Pivot Arm
35	Line Roller
35A	Line Roller Ball Bearing
35B	Line Roller Bushing
36	Bail Stud Screw
38	Rotor Nut
38A	Rotor Nut Screw
39	Spool Shaft
40B	Click Ratchet
43	Crosswind Block
44	Crosswind Block Screw
45	Housing Cover
46	Housing Cover Screw(3 req.)
47	Spool Assembly
49	Spool Click Spring
51	Retaining Ring
52	Drag Knob
56	Friction Drag Washer(3req.)
57	Keyed Washer(2 req.)
58	Drag Washer Earred
60	Thrust Washer
98	Clutch Retainer
132	Roller Washer
226	Rear Cap
226A	Rear Cap Screw
227	Cam Cover
231	Crosswind Gear
231B	Crosswind Gear Screw
233	Bearing Cover
233A	Bearing Cover Washer

PART

NO.

001	6000SV
008	5000SV
008A	5000CV
015	5000SV
019	5000SV
020	5000CV
021	5000SV
021A	2000SV
021B	5000SV
022	2000SV
022A	2000SV
022B	2000SV
024	6000SV
027	6000SV
027A	5000SV
027E	5000SV
028	6000SV
029	4000SV
031	2000SV
031A	2000SV
032	5000SV
034	5000SV
034B	5000SV
034C	5000SV
035	4000SV
035A	2000CV
035B	2000SV
036	4000SV
038	5000CV
038A	2000CV
039	5000SV
040B	5000CV
043	5000SV
044	2000SV
045	6000SV
046	2000SV
047	6000SV
049	2000CV
051	2000CV
052	5000SV
056	2000CV
057	2000CV
058	2000CV
060	5000CV
098	5000SV
132	2000CV
226	5000SV
226A	2000SV
227	5000SV
231	15000SV
231B	5000SV
233	2000SV
233A	2000SV