

POWER & EFFICIENCY

INPUT POWER OPTIONS	AC 1PH 100-120V 50/60Hz
CURRENT AT MAX SPEED (Amp)	5.2A - 4.2A
POWER (hp)	5/8 HP
MAXIMUM SPEED (RPM)	156 RPM
MAX AFFECTED AREA	40 ft Dia 1,600 sqft

DIMENSIONS & WEIGHT

FAN DIAMETER	8 ft (2.4m)
FAN WEIGHT	104lbs (47.3 kg)

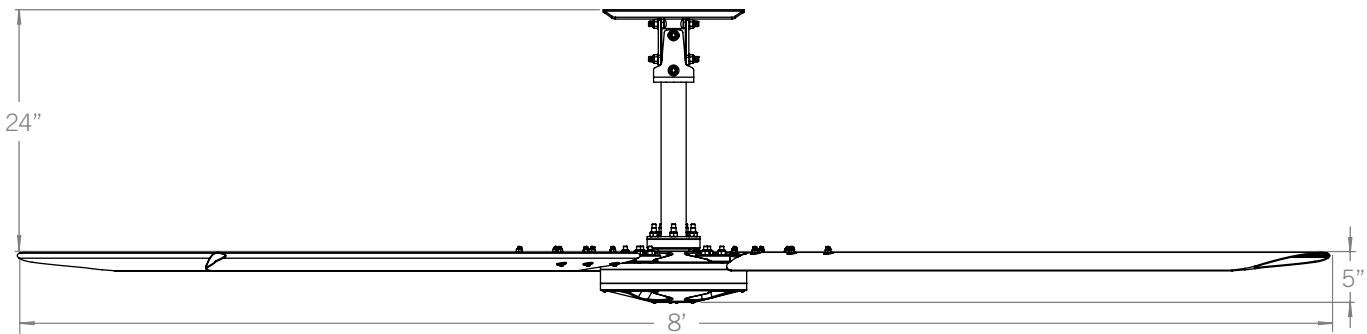

MOUNTING & SAFETY

MOUNTING OPTIONS	Rigid Mount
DOWNROD	2' Rigid Mount Downrod
SAFETY FEATURES	Fan Retention System Airfoil Retention System Fire Relay

IN THE BOX

INCLUDED	Rigid Mount with Pre-Wired Downrod Control Panel Install Manual Airfoils Wall Control Mounting Hardware Kit Communication Kit
OPTIONAL	3' and 4' Rigid Mount Downrod Additional Control Cable Lengths

WARRANTY & CERTIFICATIONS

CERTIFICATIONS	ETL/Intertek-certified to ANSI/UL 507 and CSA C22.2 No. 113 in North America
WARRANTY ¹	Limited Lifetime on Airfoils 2-year Warranty (parts only)

¹See complete warranty for details.