

LEVOLOR®

Custom Shutters

See the LEVOLOR® Shutters
sample book or visit
LEVOLOR.com/Shutters



Classic style and durability ensures years of performance with minimal care.

CUSTOM

WHY LEVOLOR® SHUTTERS?



The look of real wood with added durability;
won't warp, crack, or fade.

Waterproof design offers care-free maintenance
and makes them ideal for kitchens, bathrooms, or
waterfront homes.

All tilt options, including motorized, are Certified
Best for Kids™, making them safer for homes
with children and pets.

25-year limited lifetime warranty.

SIMPLE TOUCH SHUTTER CONTROL

Experience optimal light control and privacy with the touch of a button. LEVOLOR Motorization allows you to easily adjust your shutters using the LEVOLOR app or remote control.

Organize and operate your shutters by personal preference and the way you live. Seamlessly group and control all your LEVOLOR motorized window coverings from one device.

LEVOLOR® MOTORIZATION + APP

Download the LEVOLOR app to create custom schedules for adjusting your shutters throughout the day – whether you're home or away.



DUAL OPERATION SAVES YOU MONEY

Powered by our proprietary dual panel connector, operate two shutter panels simultaneously with one motor for a more efficient and affordable motorized solution.



Dual Panel Operation



LEVOLOR® REMOTE

ORDERING CONSIDERATIONS FOR MOTORIZATION

- Optional tilt bar can be added to a motorized shutter for a more traditional look (must be requested at the time of order)
- Panel connectors are not available with Mounting Strip Frame, French door or By-Pass applications, or frames with less than four sides

CUSTOM SHUTTERS MADE EASY

From taking measurements to selecting styles, we make it easy for you to choose the right options for your custom shutters. Our step-by-step process guides you through easy ordering and configuring to make sure every detail is addressed.

Experience simplified shopping with LEVOLOR®



Shutter Order Form Guide

As you fill out the Shutter Order Form, use these steps for guidance along the process.

1 | Name Your Room

Add a room name for reference. This will be printed on the packing slip to help identify your shutter location upon arrival.

2 | Window Measurements

Measure all windows separately, no matter how similar they appear.

NOTE: Use a durable steel tape measure. Do not use a cloth tape measures as they can stretch and provide inaccurate measurements.

2A. Window Width

- Measure the inside of the window opening, **not the glass**.
- Measure window width in 3 places. Record the narrowest measurement and round down to the nearest 1/8 inch.
- Do not make any deductions, allowances or additions.

2B. Window Height

- Measure the inside of the window opening, **not the glass**.
- Measure window height in 3 places. Record the shortest measurement and round down to the nearest 1/8 inch.
- Do not make any deductions, allowances or additions.

NOTE: All shutters must be ordered the same height to achieve a uniform appearance and equal number of louvers. If the height measurements differ, apply one of the options below:

- For inside mount mounting strip or L Frame you may reduce taller shutters up to 1/8 in maximum.
- For inside mount with Z Frame, Bullnose, Trim frame or Décor Trim Frame you may reduce taller shutters up to 1/2 inches maximum.
- For height adjustments of more than 1/2 inches, we recommend an outside mount.

2C. Window Diagonals

- Measure the inside of the window opening, **not the glass**.
- Measure window diagonals by checking distance from corner to corner and marking the result.
- Subtract the shorter number from the longer number and note in section 2C of the order form.

2

Width

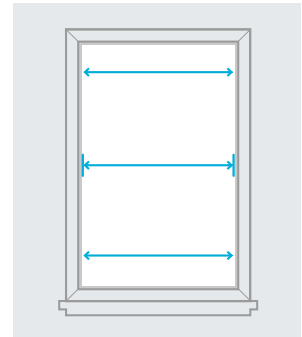

Height

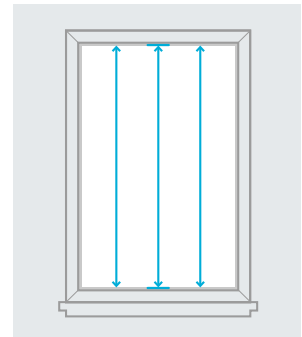

Diagonal

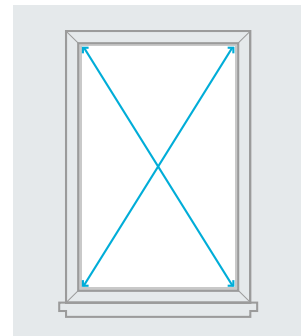

1/8 Inch

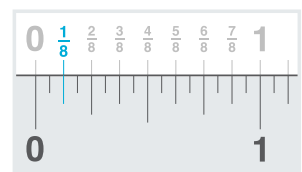

2D. Window Depth

- Measure from the front of any obstruction to the front edge of the window frame to determine depth.

NOTE: Depth clearance is the minimum window depth required for shutters to operate without interfering with window parts. Shutters can be mounted anywhere within a frame as necessary, as long as there is adequate window depth and flat surface area. Window obstructions include, but are not limited to: Window Cranks, Window Locks, Alarms and other items.

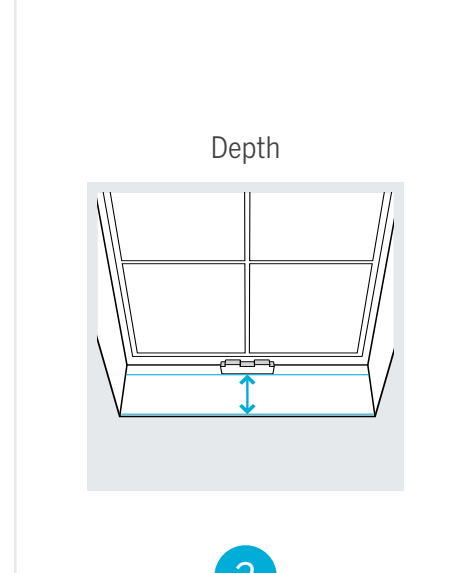

2

3 | Window Molding/Trim

Does your window have trim? If it does, what is the width of the trim?

NOTE: If window does not have molding or trim, please enter "0".

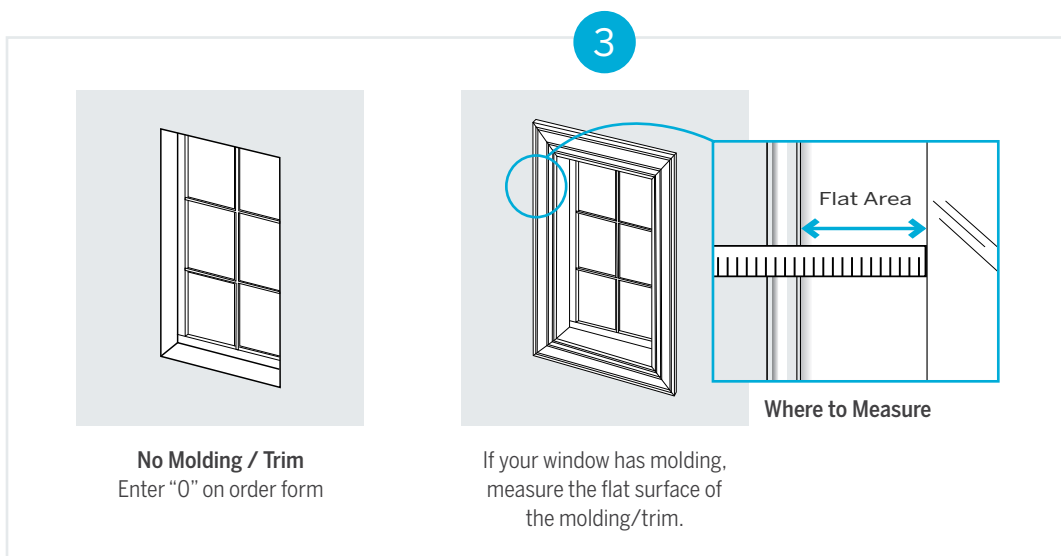

4 | Window Sill

Does your window have a window sill?

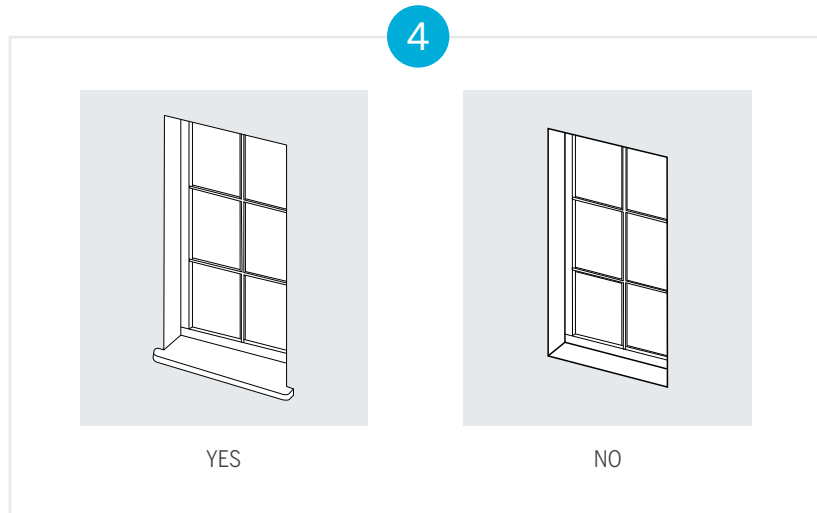

5 | Mount Type

LEVOLOR recommends Inside Mount as the preferred mounting method for an easy install and clean look, however Inside Mount may not be possible in all situations. Answer the following questions to determine your mount type.

- Does your window have less than 1 ¼ inch of depth clearance (reference your answer from Step 2D) – Circle Y/N
- Is your window more than ½ inch out of square? (reference your answer from Step 2C) – Circle Y/N
- Is the only way to open your window by tilting in? (see Figure C below) – Circle Y/N
 - If you circled "Y" to any question above, you must select Outside Mount.
 - If you circled "N" for all questions above LEVOLOR recommends you select Inside Mount.
- If you selected Outside Mount and your trim measurement (reference your answer from Step 3) is less than 1 ¾ inch (not including "0"), we do not recommend Shutters.

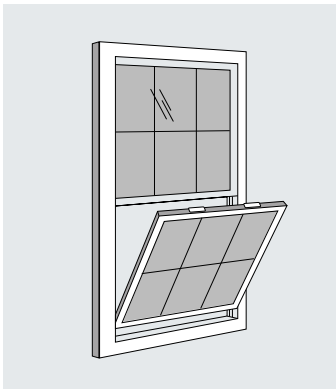
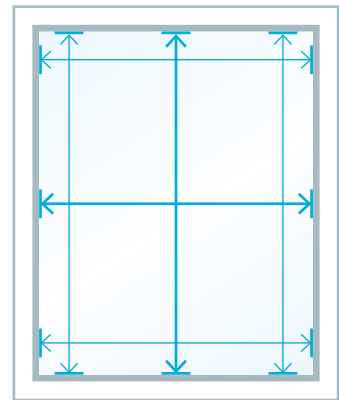

Figure C. Many windows open through both "raise/lower" as well as tilt in (for cleaning). In this case, Inside Mount may interfere with the tilt in operation of your window but can still be selected.

5

Inside Mount

Shutter will mount inside your window opening



Outside Mount

Shutter will mount outside your window opening on molding/trim or wall

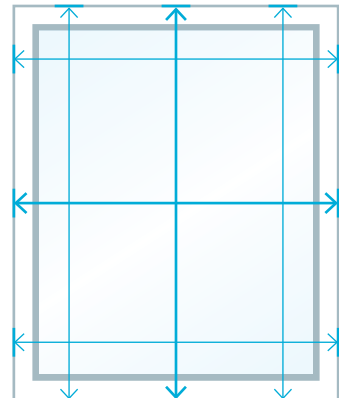

6 | Color Choice

LEVOLOR Shutters are offered in 3 neutral tones to match any decor. White is the most popular choice and offers a beautiful contrast to most paint colors, while Vanilla adds a more dramatic tone to the room.

Visit LEVOLOR.com/Shutters for free swatches to see how each color can help make this shutter fit your home.

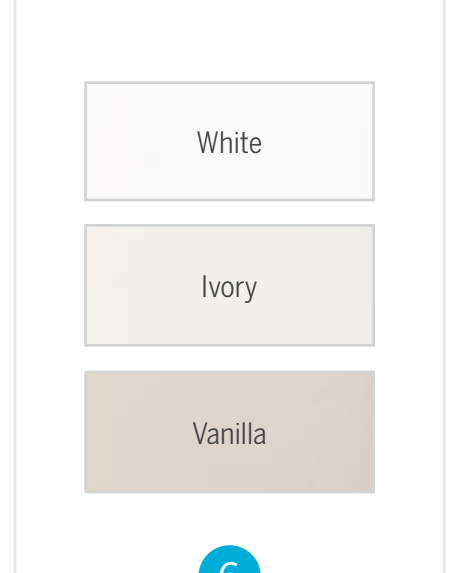

7 | Frame Styles

Frame styles add a decorative element to your custom shutter to suit your personal style. Frame options are based on mount type and trim width.

7

L Frame



Inside and Outside Mount

Z Frame



Inside Mount

Bullnose Frame



Inside Mount

Trim Frame



Inside Mount

Décor Trim Frame



Inside Mount

Casing Frame



Outside Mount

Mount Type Step 5	Trim Width Step 3	Frame Options
Inside Mount	Less than 1 3/8 in.	L Frame, Z Frame
	Greater than or equal to 1 3/8 in.	L Frame, Z Frame, Bullnose Frame, Trim Frame, Décor Trim Frame
	No Trim	L Frame, Z Frame, Bullnose Frame, Trim Frame, Décor Trim Frame
Outside Mount	Greater than or equal to 1 3/8 in.	L Frame
	Greater than 2 3/8 in.	L Frame, Casing Frame
	No Trim	L Frame, Casing Frame

NOTE: Mounting strip is a special option available to installers for inside mount applications

8 | Louver Size

The 2 ½ inch louver is the more traditional size, while the larger 3 ½ inch and 4 ½ inch louver sizes offer a more contemporary look and a greater view to the outside. Larger louvers will require more depth clearance in the window.

8

2 ½ inch Louver



3 ½ inch Louver



4 ½ inch Louver



Use the below chart and the Frame Style selected in (Step 7) as well as the Window Depth from (Step 2D) to confirm your selected louver size will work. You will need to select a different frame style if your desired louver size is not available.

MINIMUM DEPTH CLEARANCE BY FRAME			
Inside Mount (IM) – with frame or panel with front of window			
Frame Type	2 ½ inch Louver	3 ½ inch Louver	4 ½ inch Louver
Mounting Strip	2 ⅞ in.	2 ⅞ in.	2 ⅞ in.
L Frame	2 ⅞ in.	2 ⅞ in.	3 in.
Z Frame	1 ¼ in.	1 ⅝ in.	2 ½ in.
Bullnose Frame	1 ⅝ in.	1 ⅝ in.	2 ½ in.
Trim Frame	1 ⅝ in.	1 ½ in.	2 in.
Décor Trim Frame	1 ⅝ in.	1 ½ in.	2 in.
Outside Mount (OM)			
L Frame	0	½ in.	⅞ in.
Casing Frame	0	0	⅞ in.

NOTE: If your window does not meet minimum depth for outside mount, then frame extensions are available. Each frame extension will increase clearance by ½ in.

9 | Control Systems

LEVOLOR Shutters are offered in three tilt options: Tilt Bar, Gear Closure and Motorized.

- The Tilt Bar option has a centered tilt bar located on the front of the shutters, giving them a traditional look.
- The patented Gear Closure System is an optional upgrade. The hidden gear operating systems provides an unobstructed view and modern look and allows for a smooth superior closure.
- The Motorized tilt option allows you to adjust the louver position using the LEVOLOR app or remote.

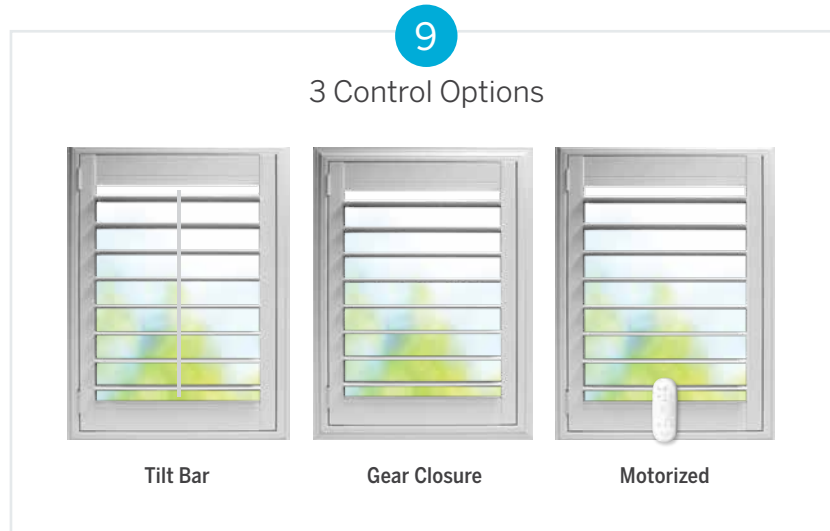

10 | Panel Configurations

The chosen panel configuration is based on P#-XXX. P# means the number of panels and x being the hinged panel side, left (L) or right (R) and T-Post. Example: P3-LTLTL means (3 - Panels - Left Hinge, T-Post, Left Hinge, T-Post, Left Hinge)

10

1 Panel

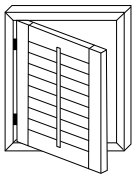

Can be hinged either left or right.
P1-L or P1-R

2 Panels

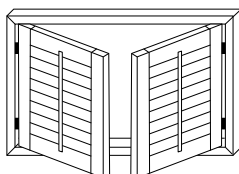

One panel hinged left & one panel hinged right. Can also be hinged (bi-fold) left or right.
P2-LR, P2-LL, or P2-RR

3 Panels

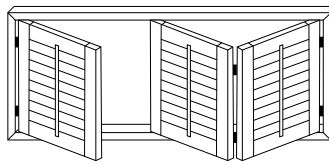

2 bi-fold right and one left or 2 bi-fold left and 1 right.
P3-LLR or P3-LRR

4 Panels

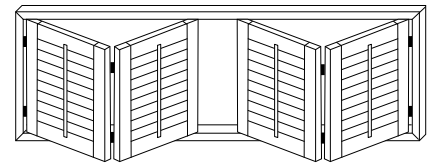

2 bi-fold left and 2 bi-fold right.
P4-LLRR

11 | Divider Rails

11A. Use divider rails to create top and bottom sections. This allows the bottom half of shutters to be fully closed for privacy, while allowing the upper half to be open. Please identify on the order form how many divider rails you would like added to your order

- A divider rail is required for any shutter panel over 66-inches in height.
- Two divider rails are required for shutter panels over 90-inches in height.
- There is no extra charge for divider rails.
- Motorized shutter panels with a divider rail require 2 motors (top & bottom)
- If there are two divider rails along with the motorized tilt, the mid-section of louvers will operate simultaneously with either the top section of louvers or the bottom section of louvers. Preferred configurations must be selected at the time of order.

11

Identifying Divider Rail Locations

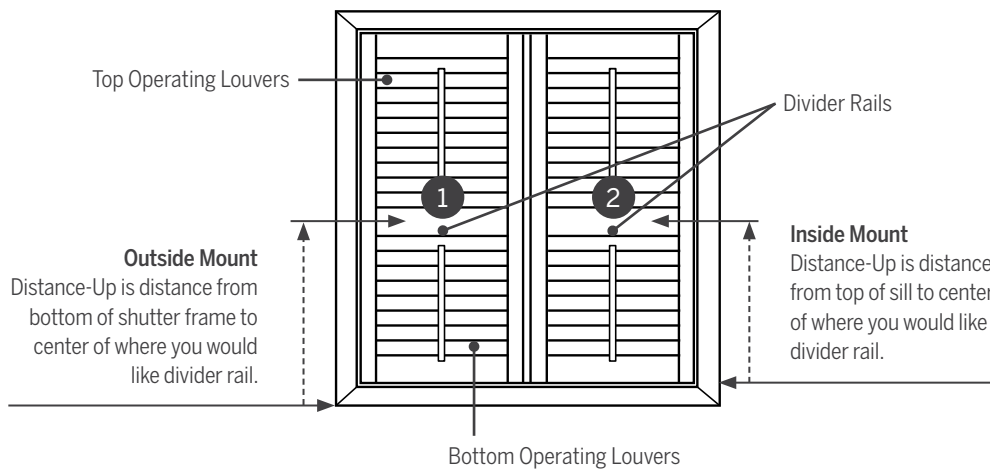

11B. Based on your shutter application, inside mount or outside mount (Step 5), estimate the divider rail placement.

Using the diagram above:

- Identify the desired location measurement of the #1 Divider Rail.
- Identify the desired location measurement of the #2 Divider Rail.
- Divider rail location may vary up or down by 1 ½ in. from the height requested.

A close-up photograph of white plantation shutters. The shutters are arranged in a grid pattern, with several slats visible. A dark blue banner is overlaid across the middle of the image, containing white text. The background behind the shutters is a bright, slightly blurred light blue.

Enjoy your LEVOLOR® Custom Shutters