











PC-F1A Self tapping female (page 1 of 2)

	USE WITH:			INSTALL WITH:			
	PC-M1A  PC-M2H 	PC-VM1  PC-VM1H 	PC-SM2  PC-SM2H 	CT-01 	CT-03 	CT-07 	CT-10 
INSTALLATION STEPS <small>(see reverse for more options)</small>							

1 Drill hole through panel & frame

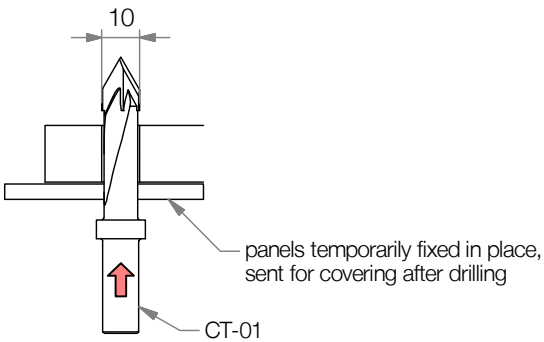

2 Drill out frame hole with CT-07

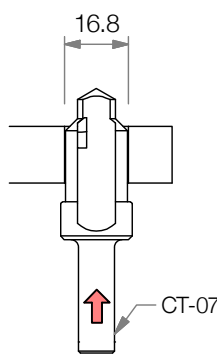

3 Screw fit PC-F1 with CT-03

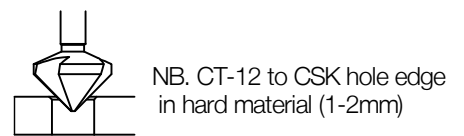
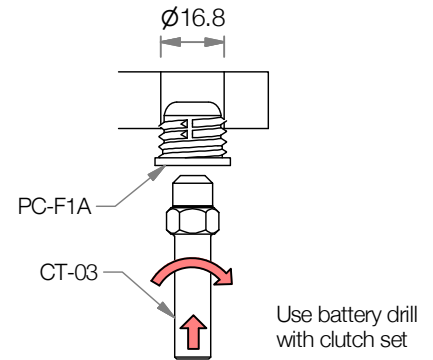

4 Screw fit PC-F1 into thin frame

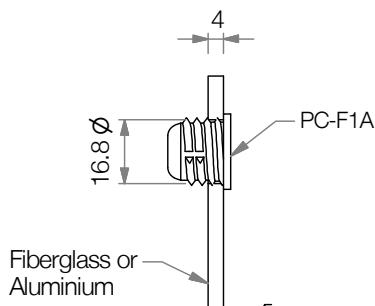





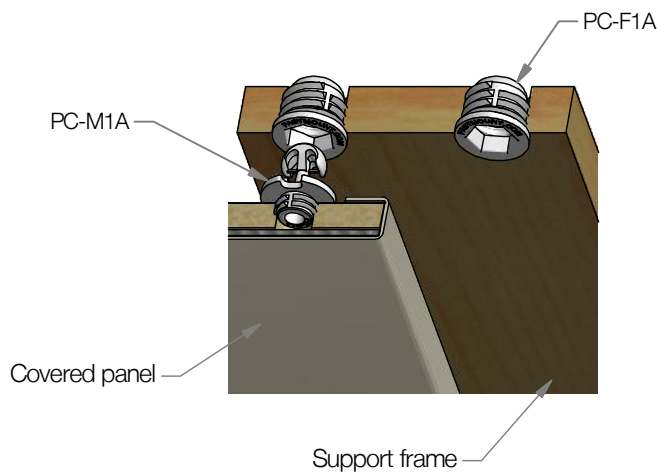





PC-F1A can be used as screw / friction fit into thin frames & seat backs

5 Cutaway view showing panel mounting



PC-F1A Self tapping female (page 2)

	USE WITH:			INSTALL WITH:			
	PC-M1A 	PC-VM1 	PC-SM2 	CP-01A  or CP01ST	CT-07 	CT-09 	CT-10 
	PC-M2H 	PC-VM1H 	PC-SM2H 				

INSTALLATION STEPS (continued from previous page)

1 Fit CP-01A into PC-F1A then push panel to mark center

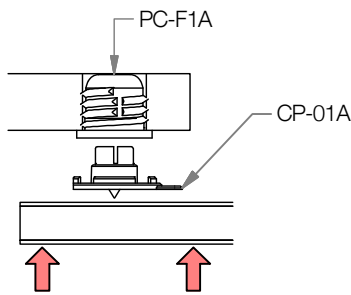

2 Drill panel on center mark with CT-09 7.5mm deep for PC-M2H

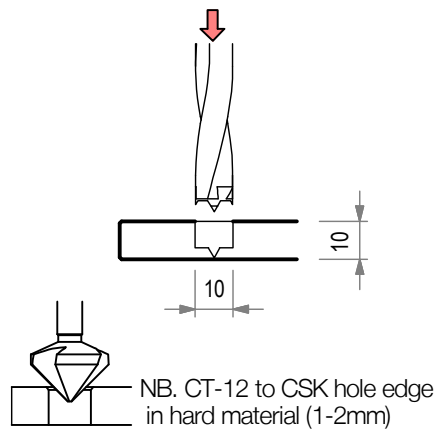

3 Screw fit male clip with CT-10

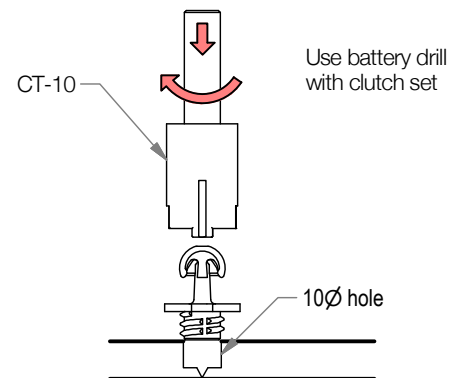

INSTALLING ADHESIVE FIT MALE CLIPS (first complete steps 1 to 3, page 1)

4 Clip PC-SM2 into PC-F1A

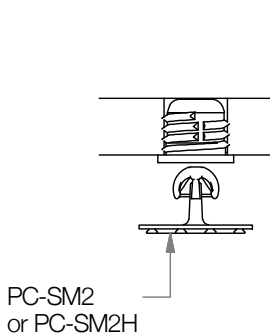

5 Apply adhesive to PC-SM2

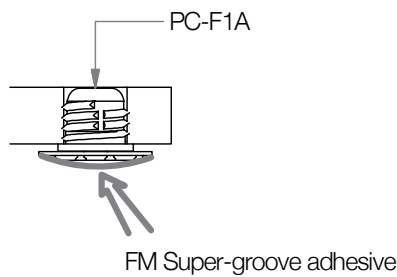

6 Place panel & support while adhesive dries

