



# aura

BLUETOOTH KEYPAD SMART LOCK

## Installation and User Guide

ENGLISH

Parts List			
<b>Mounting Plate</b> 	<b>Adapter Ring</b> 	<b>Exterior Assembly</b> 	<b>Interior Assembly</b> 
<b>Batteries</b> 	<b>Keys</b> 		
<b>Latch A</b> 	<b>For Latch / Strike</b> <b>Strike</b> 	<b>03809</b> 	<b>For Lock</b> <b>SmartKey Tool</b> 
<b>Latch B</b> 	<b>46780</b> 	<b>48654</b> 	<b>49191</b> 
		<b>64109</b> 	<b>68611</b> 

**Required tools**

Ruler Phillips head screwdriver

**Additional Tools (depending on application)**

Hammer Wood block Chisel

**Kwikset**

1-800-327-5625  
www.kwikset.com

"B" is not included. If needed, please contact Kwikset to order a drive-in latch for your lock.

### 1 Prepare the door and check dimensions

If drilling a new door, use the supplied template and the complete door drilling instructions available at [kwikset.com/doorprep](http://kwikset.com/doorprep)

**A** Make sure your door is compatible. If you have a standard deadbolt mounted separately from the handle below it, your door is compatible.

**B** Remove your existing deadbolt from your door.

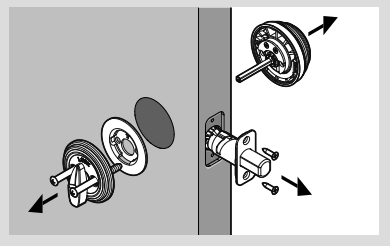
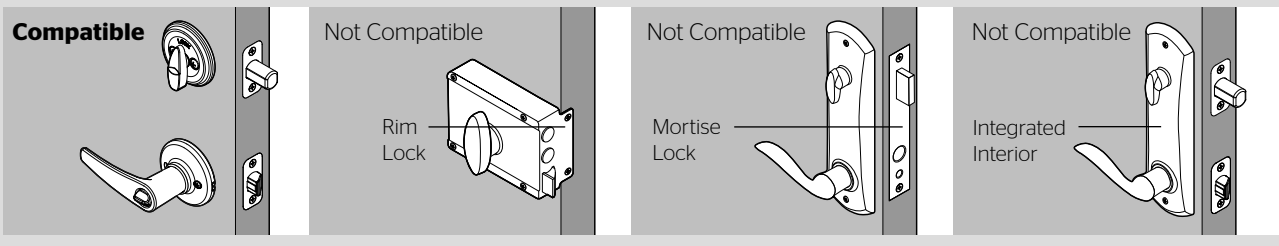

**C** Measure to confirm that the hole in the door is either 2-1/8" (54 mm) or 1-1/2" (38 mm).

**D** Measure to confirm that the backset is either 2-3/8" or 2-3/4" (60 or 70 mm).

**E** Measure to confirm that the hole in the door edge is 1" (25 mm).

**F** Measure to confirm that the door is between 1-3/8" and 2" (35 mm and 51 mm) thick.

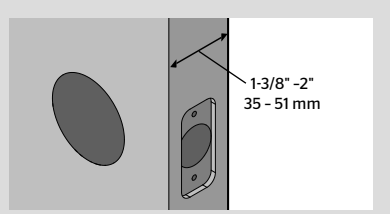
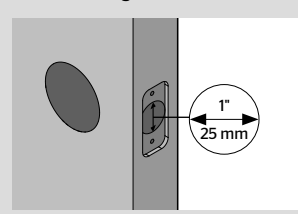
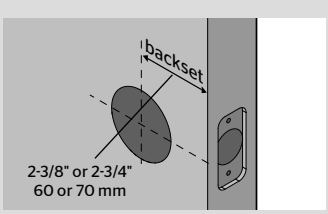
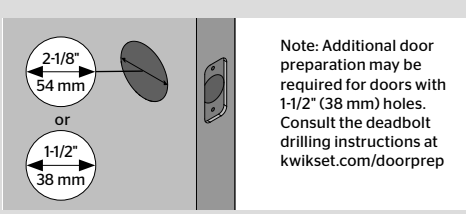

Note: Additional door preparation may be required for doors with 1-1/2" (38 mm) holes. Consult the deadbolt drilling instructions at [kwikset.com/doorprep](http://kwikset.com/doorprep)

### 2 Install the latch and strike

For Latch / Strike Bag

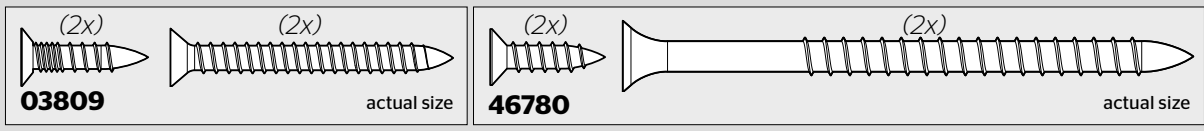

**A** Is the door edge chiseled?

**B** Hold the latch in front of the door hole, with the latch face flush against the door edge.

**D** Which latch are you installing?

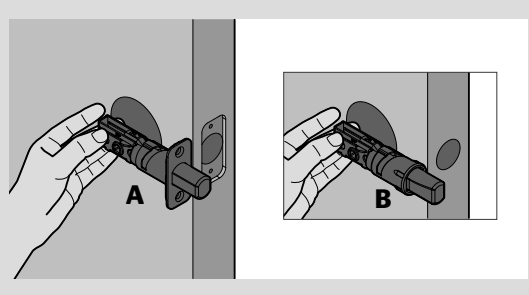
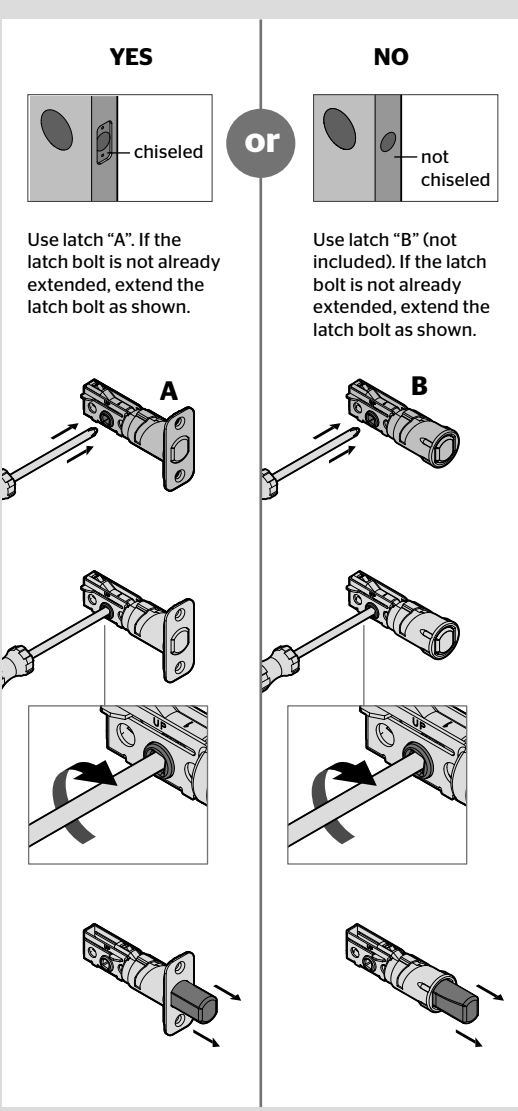

**C** Is the D-shaped hole centered in the door hole?

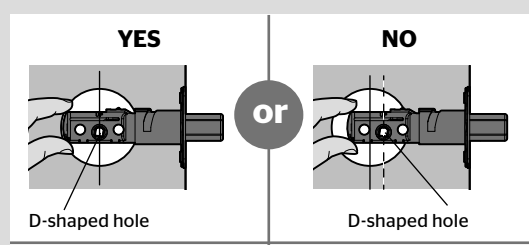

No adjustment is required. Proceed to next step.

Rotate latch face as shown to extend latch.

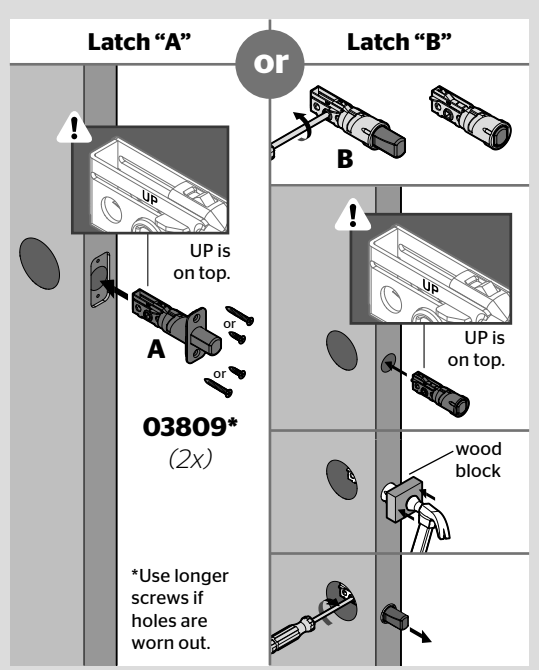
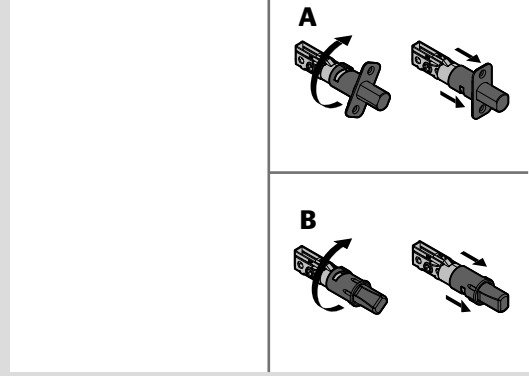

**E** Install the strike on the door frame.

⚠ Make sure the hole in the door frame is drilled a minimum of 1" (25 mm) deep.

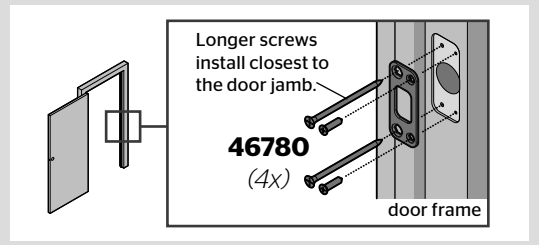

### 3 Install the exterior keypad

For Lock Bag

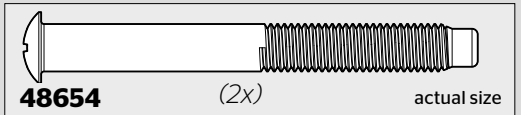

**A** What is the diameter of the hole in the door?

**Diameter is 2-1/8" (54 mm)**

Adapter Ring is required for installation. Install on Exterior Assembly.

**Diameter is 1-1/2" (38 mm)**

Adapter Ring is not needed for installation and may be discarded.

**B** Locate the screws for step 3D and keep them within reach.

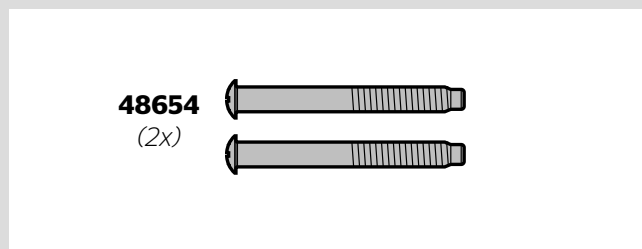

**C** Remove the mounting plate from the interior assembly.

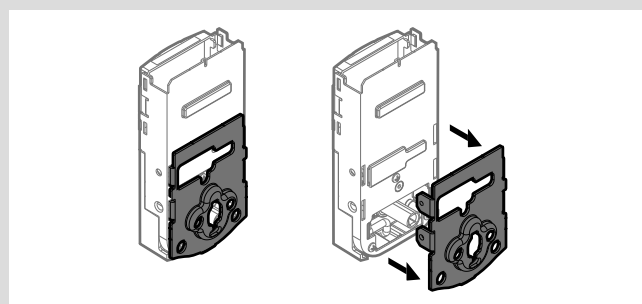

**D** Install the exterior keypad and mounting plate.

**a**

The cable goes underneath the latch.

**b**

Support the exterior assembly during mounting plate installation.

Route the cable through the center hole, then push it into the bottom hole.

**c**

Keep parallel to the edge of the door.

48654 (2x)

Tighten screws evenly. **DO NOT** over tighten screws.

**d**

Insert the key and test the latch. If the latch does not extend or retract smoothly, adjust the screws.

Remove the key when finished, and make sure the latch bolt is fully extended.

### 4 Install the interior assembly

For Lock Bag

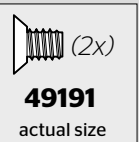

**A** Ensure the turnpiece shaft is pointing up, and remove the interior cover and battery pack from the interior assembly.

**a**

Remove the interior cover from the interior assembly.

**b**

Make sure turn piece shaft is rotated as shown.

Incorrect:

If turnpiece shaft is not oriented correctly, put the cover back on and rotate the turnpiece as shown in step C.

**c**

If the turnpiece shaft is pointing down, place the cover back onto the interior assembly and rotate the turnpiece until you hear it click. You may need to apply some force. Once the turnpiece shaft is correctly oriented, remove the cover again.

**d**

Do not install batteries until step 5.

**B** Install the interior assembly onto the mounting plate.

**a**

Ensure tight cable connection.

align

**b**

Lay the excess cable flat inside the bottom of the interior housing.

**c**

**d**

49191 (2x)

bottom hole

Ensure you are using the correct screws. Using incorrect screws will damage the product.

## 5 Install the batteries and perform the door handing process

This step will teach your lock the orientation of your door and is crucial to lock operation.

**A** Install 4 AA batteries in the battery pack.

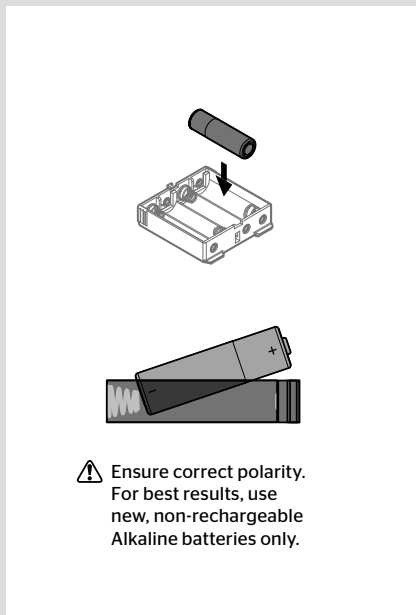

**B** With the door open, install the battery pack to initiate auto-handing.

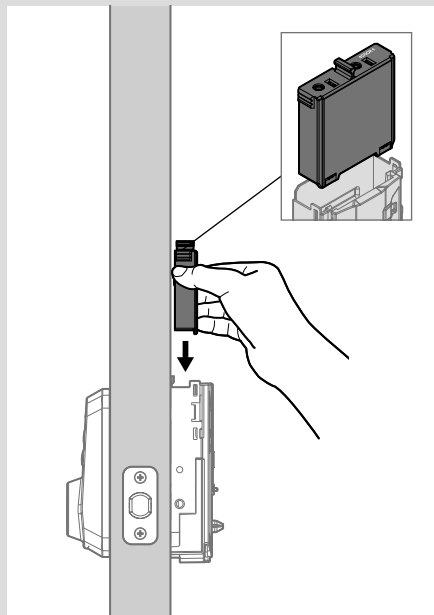

**C** The latch will retract and extend to learn the orientation of the door.

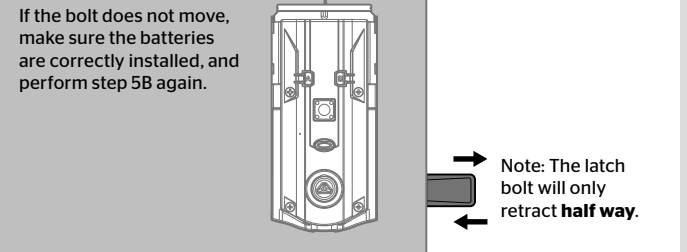

**D** The Status LED will indicate success or failure.

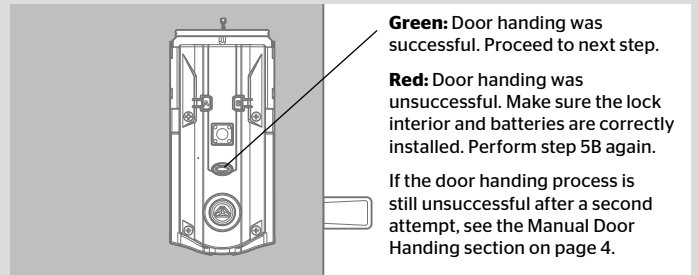

## 6 Test the lock and check door alignment

**A** With the door open, insert the key to extend the latch. Ensure that the latch extends smoothly.

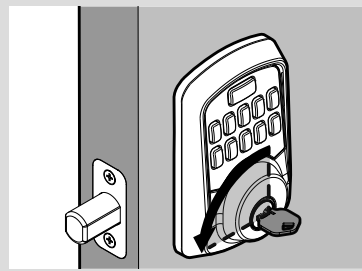

**B** Turn the key 180° to retract the latch. Ensure that the latch retracts smoothly.

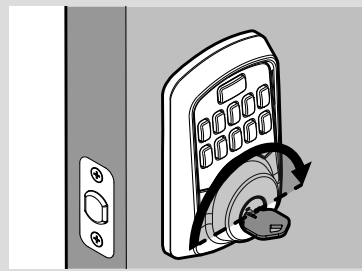

**C** Close the door. Insert and rotate the key to lock the door. Ensure that the door locks smoothly.

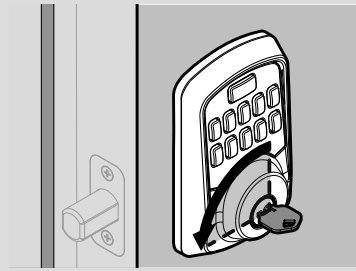

**D** Turn the key 180° to retract the latch. Ensure that the door unlocks smoothly.

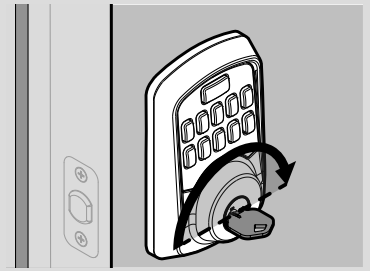

⚠️ If your door does not lock and unlock smoothly, make sure you replaced your previous latch and strike with those supplied in the box. If you still experience locking errors, call Kwikset Support to order a Warped Door Service Kit.  
 Kwikset Support: 1-800-327-5625

## 7 Install the interior cover

### Important Information about the interior cover

The window on the interior cover is unlocked by default for easier access to the battery pack and buttons.

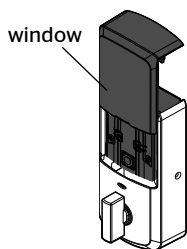

For additional security, you may choose to lock the window by installing the security screw.

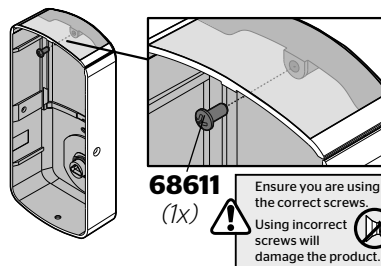

When the window is locked, you will need to remove the entire interior cover and screws to access the battery pack and buttons.

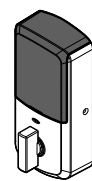

For Lock Bag

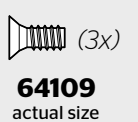

### Cover Installation

**a** Install cover.

Note: You may need to rotate the turn piece to align with the turn piece shaft.

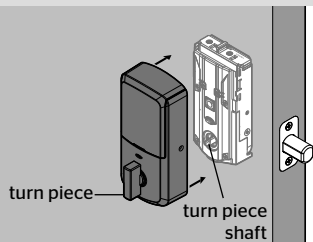

**b** Install screws.

**64109 (3x)**  
 Ensure you are using the correct screws. Using incorrect screws will damage the product.



### Battery Pack Access

If the window is unlocked, slide up the window to access the battery pack.

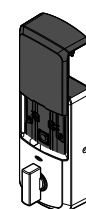

If the window is locked, remove the interior cover and screws to access the battery pack.

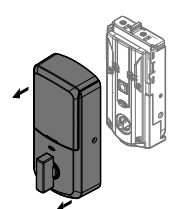

## 8 Download the app and create an account

⚠️ The Kwikset app is needed to use this lock. If this lock was professionally installed (or installed by someone other than the homeowner), make sure this step is performed by the homeowner.

**A** Download the Kwikset app by scanning the QR code or visiting [www.kwikset.com/app](http://www.kwikset.com/app) on your smartphone.



**B** Create your account and follow the setup instructions in the Kwikset app.

### SmartCode at a Glance

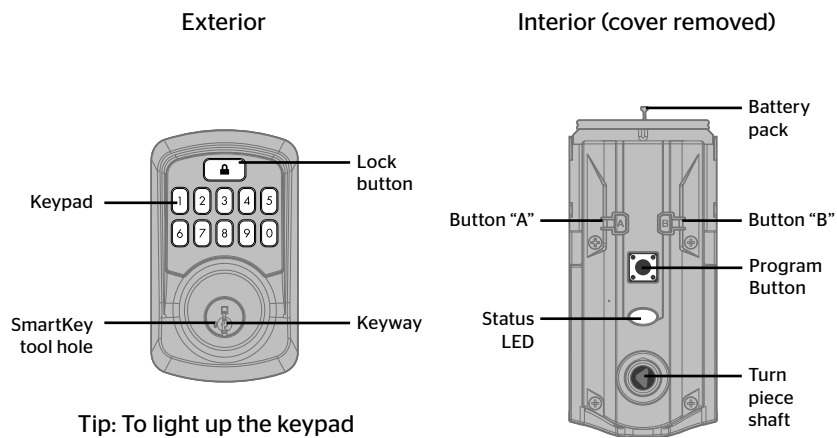

Tip: To light up the keypad while the door is locked, press the Lock button before entering your user code. The keypad will not light up if the door is unlocked.

### System Alerts

Alert	Reason	Solution
Keypad flashes red once with one beep*.	One incorrect code entered.	Re-enter code.
Keypad flashes red three times with three beeps*.	No user code programmed.	Program at least one user code.
Keypad flashes red 15 times with 15 beeps*.	Three incorrect codes entered.	Re-enter code after 60 second keypad lockout.
Keypad flashes red with fast beeping sound for three to four seconds.	Low battery.	Replace batteries.
Keypad flashes red with continuous beeping sound for two seconds.	Door jammed while attempting to lock.	Manually re-lock door. If needed, reposition strike.
Lock beeps continuously.	Interior assembly is disconnected from exterior.	Remove battery pack, reconnect the interior to the exterior, then reinstall battery pack.

\*Beeping sounds will only be heard if Lock Sounds have not been disabled in the app.

### Status LED colors

These features can be adjusted in some smart home apps.

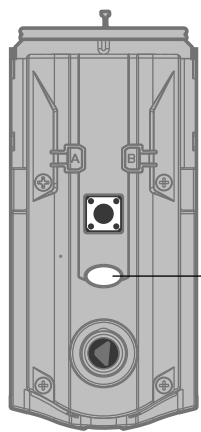

Color	Lock Status
Green (solid)	Action successful
Green (blinking)	Unlocked
Red (solid)	Door handing process unsuccessful
Red (blinking)	Action unsuccessful or incomplete Low battery
Blue (solid)	Bluetooth Pairing successful
Blue (blinking)	Bluetooth Pairing Mode
Amber (solid)	Entering Network Reset mode
Amber (blinking)	Network or System Reset mode. Action required.
	Locked

### Manual Door Handing

If needed, the door handing process can be initiated manually. This is useful if the lock is being moved to a different door.

- Remove battery pack.
- Press and HOLD the Program button while reinserting the battery pack. Release the Program button after 3 seconds. The status LED will flash red and green.
- Press the Program button once more.
- The latch bolt will extend and retract to learn the orientation of the door. The LED will flash green if handing is successful or red if handing is unsuccessful.

### Network Reset

Network Reset will delete all Bluetooth pairings, user associations, and remove the lock from the account.

- Press and HOLD "A" for 10 seconds. You will hear 1 short beep and see an amber LED. Note: After 3 seconds, you will hear 1 short beep and see a blue LED. You should continue to hold "A" to enter network reset mode.
- Release "A." You will see a blinking amber LED to indicate it is in network reset mode.
- Press and release the Program button to confirm network reset. The Program button must be pressed within 10 seconds of releasing "A" or the function will time out.
- If successful, you will hear 1 long beep and see a green LED. If unsuccessful, you will hear 5 rapid beeps and see a blinking red LED. If unsuccessful, repeat from step 1.

### System Reset

System Reset will delete all access codes and lock settings including lock handing. The lock will run the handing process at the end of the System Reset.

- Press "A" 10 times. You will hear 1 short beep and see a blinking amber LED to indicate it is in system reset mode.
- Press and release the Program button to confirm system reset.
- If successful, you will hear 1 long beep and see a green LED, and the reset process will begin. During the reset process, the LED will blink green/red a few times and will beep when complete. If unsuccessful, you will hear 5 rapid beeps and see a blinking red LED. If unsuccessful, repeat from step 1.

### Factory Reset

Factory Reset will delete all Bluetooth pairings, user associations, remove the lock from the account and reset all lock settings including handing.

- Remove battery pack.
- Press and HOLD the Program button while reinserting the battery pack. Keep holding the button for 30 seconds until the lock beeps and the status LED flashes red.
- Press the Program button once more. The LED will flash green and red, and the auto-handing process will begin.
- The latch will retract and extend to learn the orientation of the door. The LED will flash green if auto-handing is successful or red if auto-handing is unsuccessful.

### Troubleshooting

A complete Aura Bluetooth Keypad Programming and Troubleshooting Guide is available at [www.kwikset.com/aura/support](http://www.kwikset.com/aura/support)

### SmartKey Re-Keying

Re-key the lock to work with your existing key. See the supplied SmartKey Re-key instructions for more information.

Note: If Auto-Lock is enabled, remove the battery pack before re-keying your lock.

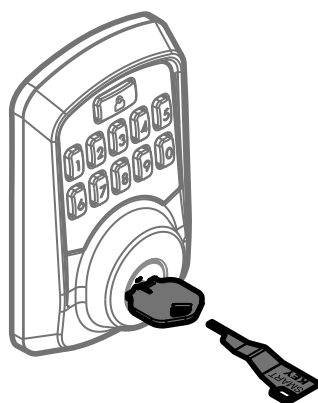

### Important Safeguards

- Read all instructions in their entirety.
- Familiarize yourself with all warning and caution statements.
- Remind all family members of safety precautions.
- Protect your user codes.
- Dispose of used batteries according to local laws and regulations.

**WARNING:** This Manufacturer advises that no lock can provide complete security by itself. This lock may be defeated by forcible or technical means, or evaded by entry elsewhere on the property. No lock can substitute for caution, awareness of your environment, and common sense. Builder's hardware is available in multiple performance grades to suit the application. In order to enhance security and reduce risk, you should consult a qualified locksmith or other security professional.